

Article number: 3902150015545

Description: Worm gear
VF 150-FC1-15-112B5, without lubrication

Measures

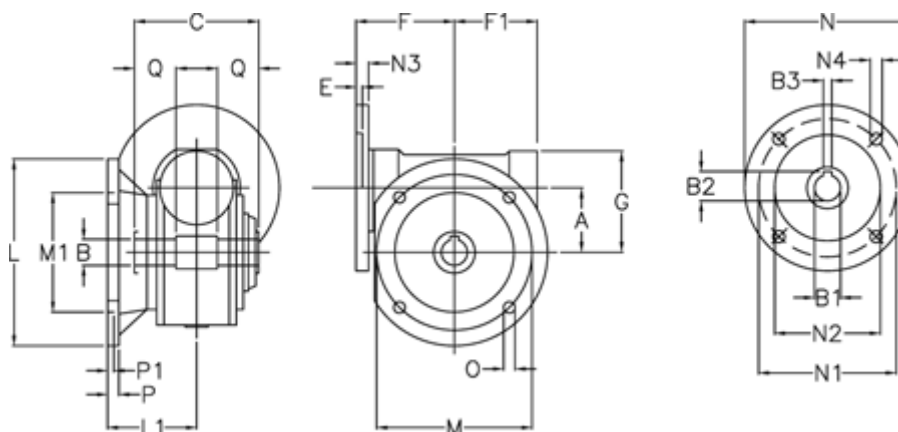

A = 150	F1 = 179	N2 = 180
B = 50 H7	G = 218	N3 = 11
B1 E7 = 28	L = 350	N4 = 13
B2 = 31.3	L1 = 145.5	O = 18
B3 H9 = 8	M = 290	P = 22
C = 175	M1 = 200	P1 = 13
E = 2	N = 250	Q = 55
F = 190	N1 = 215	